



Centrifugalventilator med lukket ventilatorvinge, der anvendes til punktudsugning fra luftforurenende eller spångivende arbejdsprocesser. Transporteret luft må ikke indeholde klæbende eller klistrende dampe eller støv.

Arbejdsområde:

Max tryk: 5.800Pa

Max luftmængde: 32.500m³/h

Max støvmængde: 5g/m³, ikke klæbende

Max partikelstr.: 5x5x5mm, ikke klæbende.

Temperatur: Udsuget luft (transportluft i ventilator) = max. 60°C

Rumtemperatur = max. 40°C

Ventilator varenr.	Opnået virkningsgrad	Måleopstilling	Type virkningsgrad	Virkningsgrad klassificering	VSD	Produktionsår	Producent side	Modelnr./type	Motorindgangseffekt, volumenstrøm og vakuum v/ optimal virkningsgrad			Omdr./min.	Trykforhold	Skrotning side	Miljø side	Opstilling måling side
									kW	m ³ /h	Pa (Ps)					
03 400 700	50,3	D	Total	■	NO	CE-mærke	0.B4	RV 35/1-C2	3,45	1590	3900	2901	1,04	0.B4	0.B4	0.B4
03 401 700	51,3	D	Total	■	NO	CE-mærke	0.B4	RV 35/2-C2	4,40	2156	3780	2925	1,04	0.B4	0.B4	0.B4
03 402 000	51,3	D	Total	■	NO	CE-mærke	0.B4	RV 35/3-C2	5,04	2700	4085	2945	1,04	0.B4	0.B4	0.B4
03 406 400	64,3	D	Total	■	NO	CE-mærke	0.B4	RV 45-C2	8,08	5432	3380	2933	1,03	0.B4	0.B4	0.B4
03 410 400	68,2	D	Total	■	NO	CE-mærke	0.B4	RV 50-C2	9,84	6561	3610	2942	1,04	0.B4	0.B4	0.B4
03 415 000	61,3	D	Total	■	NO	CE-mærke	0.B4	RV 60-C2	15,53	11305	2910	2944	1,03	0.B4	0.B4	0.B4
03 417 300	65,3	D	Total	■	NO	CE-mærke	0.B4	RV 70-C2	20,41	12270	3850	2955	1,04	0.B4	0.B4	0.B4
03 418 00001	76,7	D	Total	■	NO	CE-mærke	0.B4	RV 80-C2	27,14	13557	5640	2977	1,06	0.B4	0.B4	0.B4
03 418 50001	69,3	D	Total	■	NO	CE-mærke	0.B4	RV 85-C2	32,44	19167	4220	2968	1,04	0.B4	0.B4	0.B4
03 419 00001	75,8	D	Total	■	NO	CE-mærke	0.B4	RV 90-C2	35,54	18706	5080	2981	1,05	0.B4	0.B4	0.B4
03 420 000	55,6	D	Total	■	NO	CE-mærke	0.B4	RV 35-C4	0,71	1444	960	1446	1,01	0.B4	0.B4	0.B4
03 422 400	56,3	D	Total	■	NO	CE-mærke	0.B4	RV 50-C4	1,40	3708	750	1449	1,01	0.B4	0.B4	0.B4
03 423 000	61,6	D	Total	■	NO	CE-mærke	0.B4	RV 60-C4	2,03	4347	1005	1476	1,01	0.B4	0.B4	0.B4
03 425 300	58,6	D	Total	■	NO	CE-mærke	0.B4	RV 70-C4	2,32	4945	970	1470	1,01	0.B4	0.B4	0.B4
03 426 00001	67,9	D	Total	■	NO	CE-mærke	0.B4	RV 80-C4	3,70	8371	1060	1465	1,01	0.B4	0.B4	0.B4
03 427 00001	66,7	D	Total	■	NO	CE-mærke	0.B4	RV 85-C4	4,32	7533	1350	1481	1,01	0.B4	0.B4	0.B4
03 428 00001	66,2	D	Total	■	NO	CE-mærke	0.B4	RV 90-C4	4,85	8170	1380	1479	1,01	0.B4	0.B4	0.B4

■ Ikke godkendt i henhold til EU327/2011 ERP 2015
Må indsættes på renluftsde af Gram-filteranlæg som transportventilator jf. EU 327/2011 og EN 13349/2010

Konstruktion:

Radialventilator med lukket ventilatorvinge monteret i fuldsvejst stål kabinet og med direkte koblet motor.

Model: C (Transport of dust)

Vinge: Løbehjul type P-G, lukket vinge med bagudrettede lige, selvrensende skovlblade
Statisk/dynamisk afbalanceret jf. ISO 14694 (BV3 G 6,3)

Hus: Opsvejst i 3 eller 4mm stålplade

Standard lakering: Pulverlak for indendørs montage (RAL 5007), for udendørs placering anbefales tillige galvanisering

Ventilatorhuset kan monteres med varierende udløbspositioner (RD0, RD45, RD90, RD135, RD270 og RD315)

Motor: IE3, B3 flangemotor (Ved motorstørrelser fra 11,0kW og opefter er motor inkl. bimetalføler)
3x400V 50Hz (3-fasede motorer kan frekvensreguleres)

Ventilator type RV-C kan også leveres galvaniseret og i gnistfri udførelse (kobberring i indløb)
For ATEX-ventilatorer - se gruppe 10

Konstrueret og testet i henhold til:

- Maskindirektivet 2006/42/EF
- EMC direktivet 2014/30/EU
- Direktiv 2014/35/EU om lavspænding
- Harmoniserede standarder: EN 12100, EN 60204-1, EN ISO 13857, ISO 12499
- Øvrige standarder: ISO 3746, ISO 5801 samt: EU forordning nr. 327/2011 (ERP 2013 og 2015)



Type	Varenr.	Volt [V]	[Omdr./min.]	[kW]	Mærkestrøm (Amp)	Startstrøm [I_L/I_N]	Vægt [kg]
RV 35/1-C2	03 400 700	3x400	2-polet	3,00	■	■	81,0
RV 35/2-C2	03 401 700	3x400	2-polet	4,00	■	■	92,0
RV 35/3-C2	03 402 000	3x400	2-polet	5,50*	■	■	97,0
RV 45-C2	03 406 400	3x400	2-polet	7,50	■	■	150,0
RV 50-C2	03 410 400	3x400	2-polet	11,00*	■	■	185,0
RV 60-C2**	03 415 020	3x400	2-polet	15,00	■	■	291,0
RV 70-C2**	03 417 320	3x400	2-polet	22,00	■	■	357,0
RV 80-C2**	03 418 020	3x400	2-polet	30,00	■	■	467,0
RV 85-C2**	03 418 520	3x400	2-polet	37,00	■	■	496,0
RV 90-C2**	03 419 020	3x400	2-polet	45,00	■	■	565,0
RV 35-C4	03 420 000	3x400	4-polet	0,75	■	■	70,0
RV 50-C4**	03 422 400	3x400	4-polet	1,50	■	■	111,0
RV 60-C4**	03 423 020	3x400	4-polet	2,20	■	■	189,0
RV 70-C4**	03 425 320	3x400	4-polet	3,00	■	■	201,0
RV 80-C4**	03 426 020	3x400	4-polet	4,00	■	■	266,0
RV 85-C4**	03 427 020	3x400	4-polet	5,50	■	■	299,0
RV 90-C4**	03 428 020	3x400	4-polet	5,50	■	■	305,0

* Forhøjet effekt

** Tungt-startende

Motordata $\geq 0,75$ kW, 3x400V, jf. IE3-motorer.

■ Se afsnittet "Generelle informationer" vedr. elektromotorer

Tillæg for ændring af hus-position fra RD0 til RD45, RD90, RD135, RD270 samt RD315 (varenr. 03 365 150).

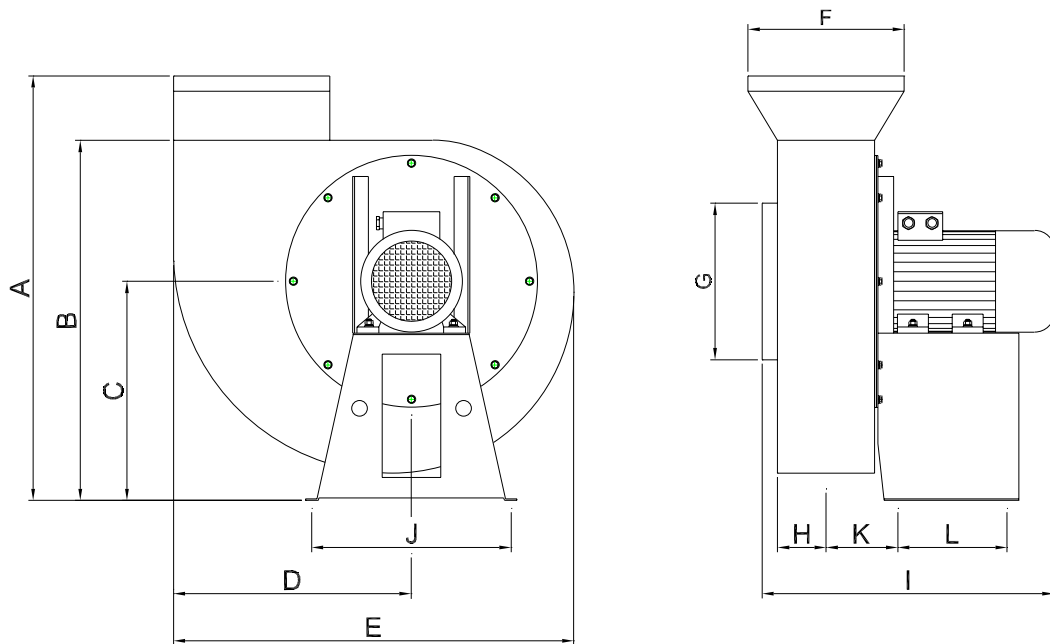

Type	Varenr.	A	B	C	D	E	F	G	H	I	J	K	L
RV 35/1-C2	03 400 700	935	765	465	385	705	ø250	ø250	66	548	375	129	235
RV 35/2-C2	03 401 700	935	765	465	385	705	ø250	ø250	73	536	375	136	237
RV 35/3-C2	03 402 000	935	765	465	385	705	ø250	ø250	80	550	375	143	235
RV 45-C2	03 406 400	1012	829	515	485	837	ø315	ø315	177	737	500	193	300
RV 50-C2	03 410 400	1017	829	515	507	859	ø400	ø400	161	870	500	217	300
RV 60-C2	03 415 020	1235	1066	705	610	1025	ø500	ø500	160	910	558	309	330
RV 70-C2	03 417 320	1230	1066	705	671	1086	ø630	ø630	176	1087	558	322	330
RV 80-C2	03 418 020	1398	1145	739	806	1275	ø800	ø800	189	1339	600	224	440
RV 85-C2	03 418 520	1398	1145	739	806	1275	ø800	ø800	202	1348	600	238	440
RV 90-C2	03 419 020	1398	1145	739	806	1275	ø800	ø800	214	1440	600	250	440
RV 35-C4	03 420 000	935	765	465	385	705	ø250	ø250	80	550	375	143	235
RV 50-C4	03 422 400	1017	829	515	507	859	ø400	ø400	161	747	500	217	300
RV 60-C4	03 423 020	1235	1066	706	610	1025	ø500	ø500	160	910	558	309	330
RV 70-C4	03 425 320	1230	1066	705	671	1086	ø630	ø630	176	997	588	322	330
RV 80-C4	03 426 020	1398	1145	739	806	1275	ø800	ø800	189	1094	600	224	440
RV 85-C4	03 427 020	1398	1145	739	806	1275	ø800	ø800	202	1108	600	238	440
RV 90-C4	03 428 020	1398	1145	739	806	1275	ø800	ø800	214	1118	600	250	440

Bemærk: Mål på studse er nippelmål

2-polet:

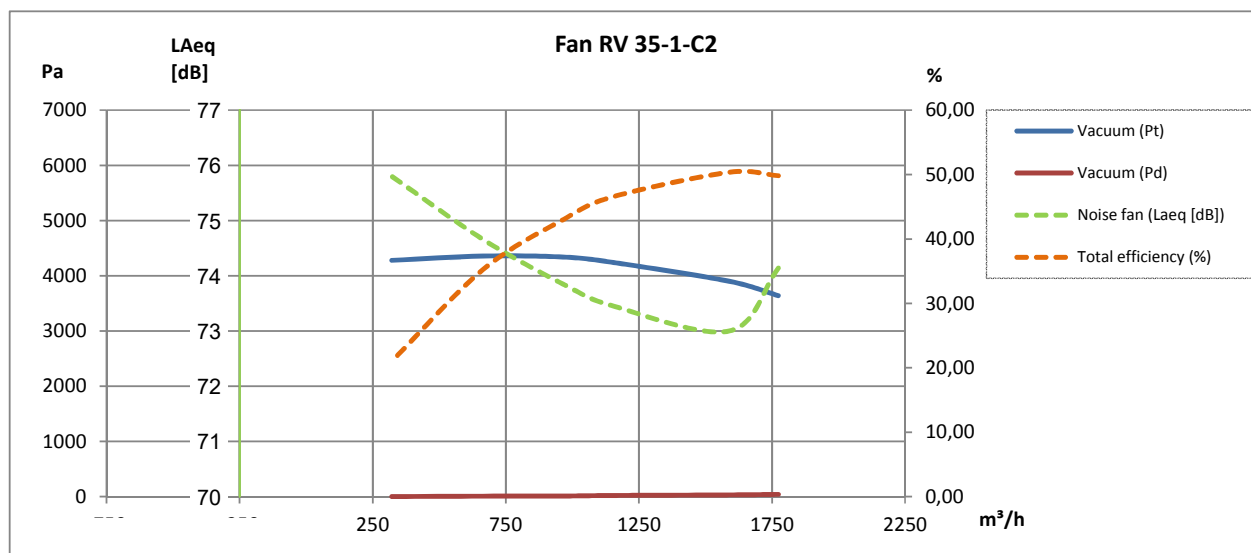

2-polet:

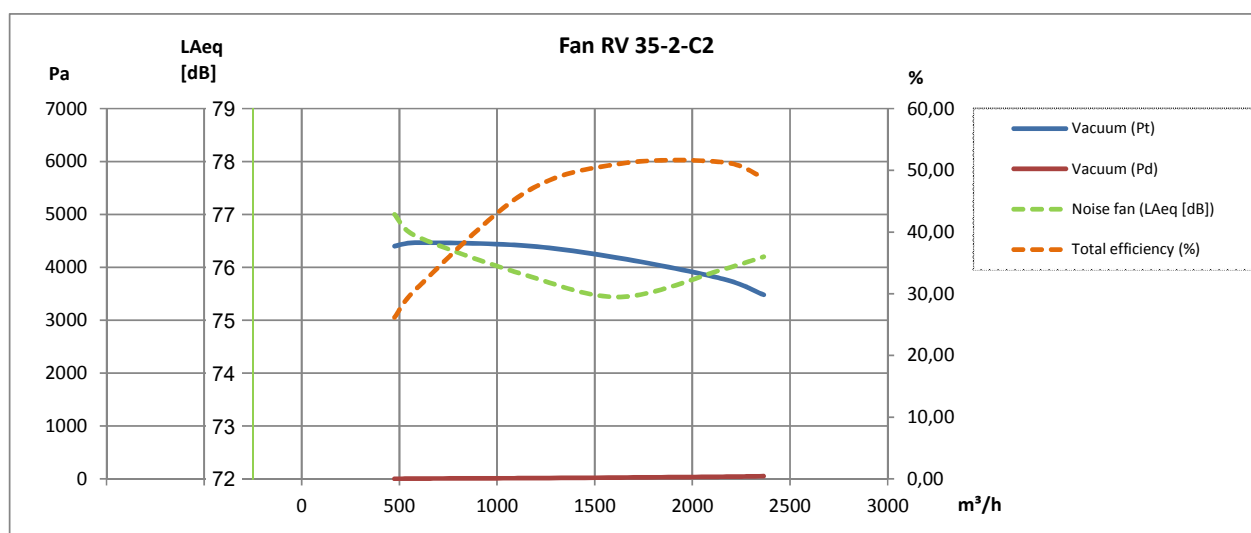

2-polet:

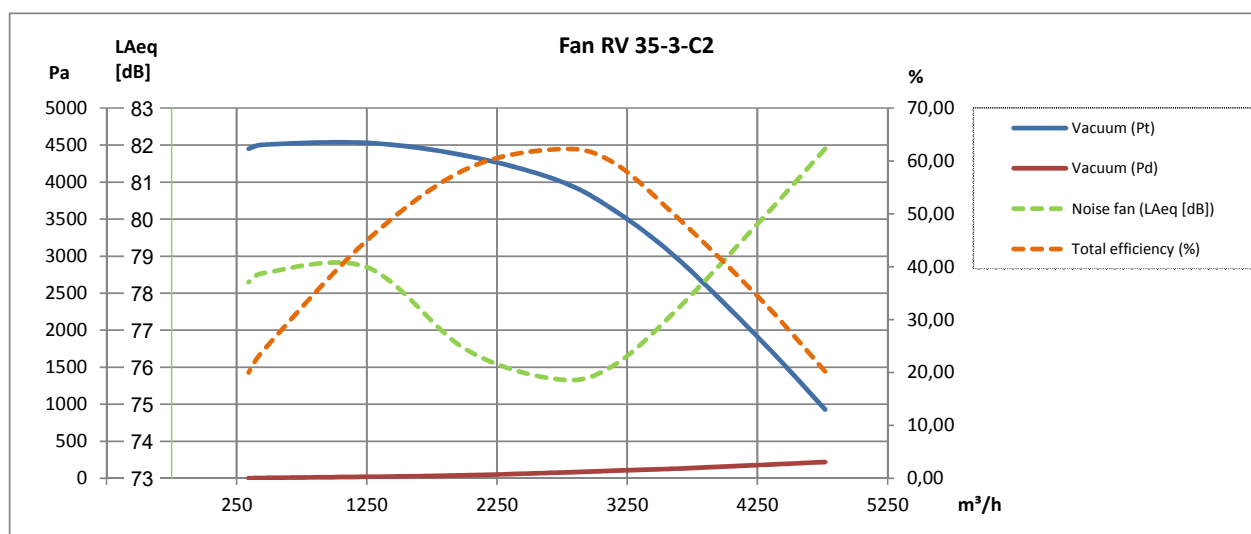

Rev. 05.23 Ret til ændringer forbeholdes

2-polet:

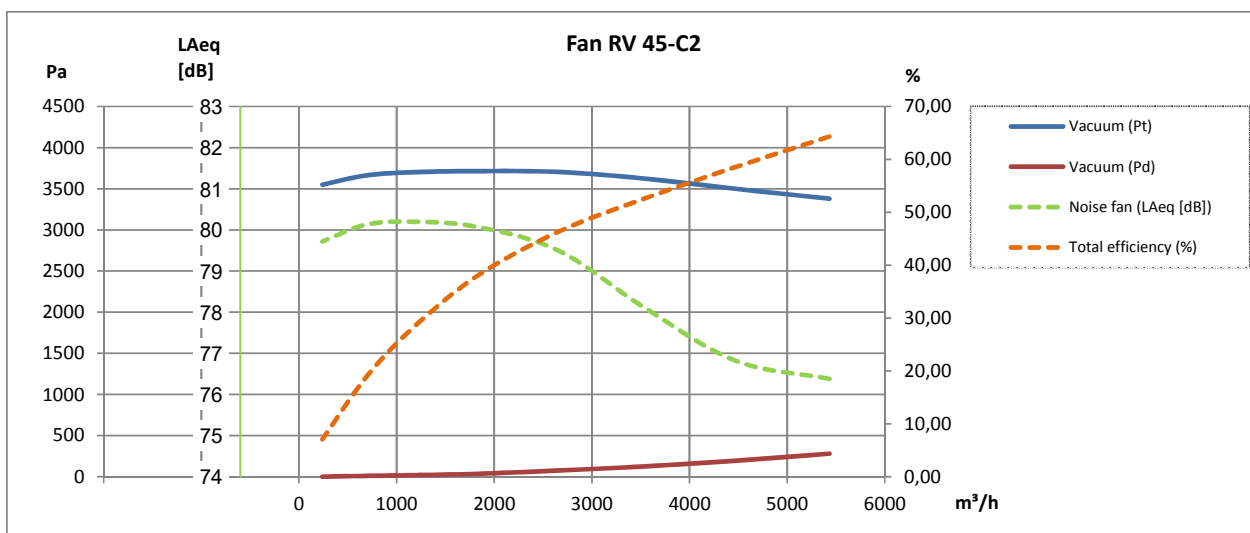

2-polet:

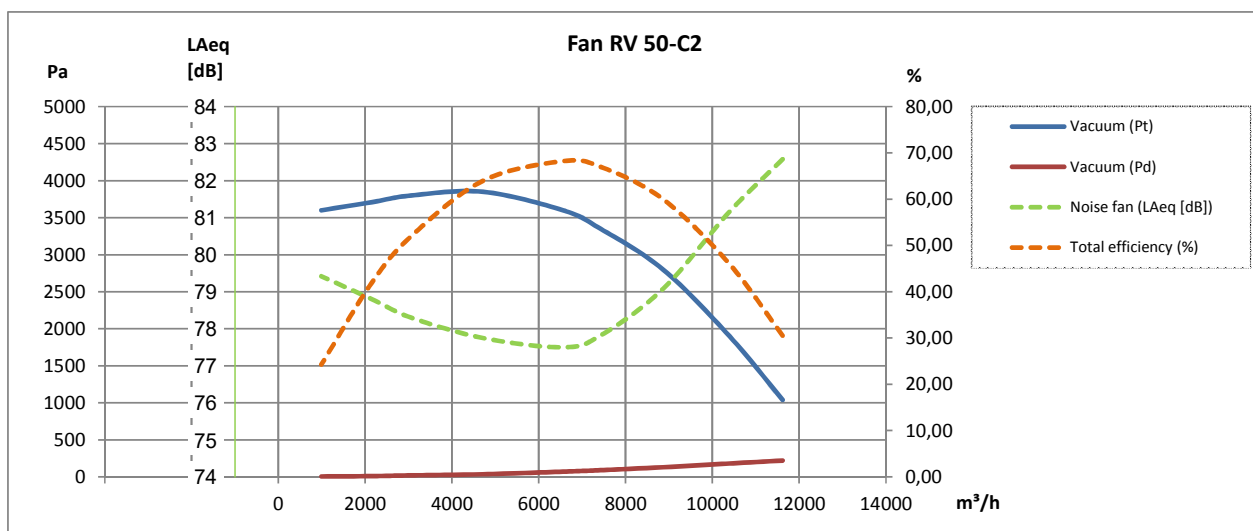

2-polet:

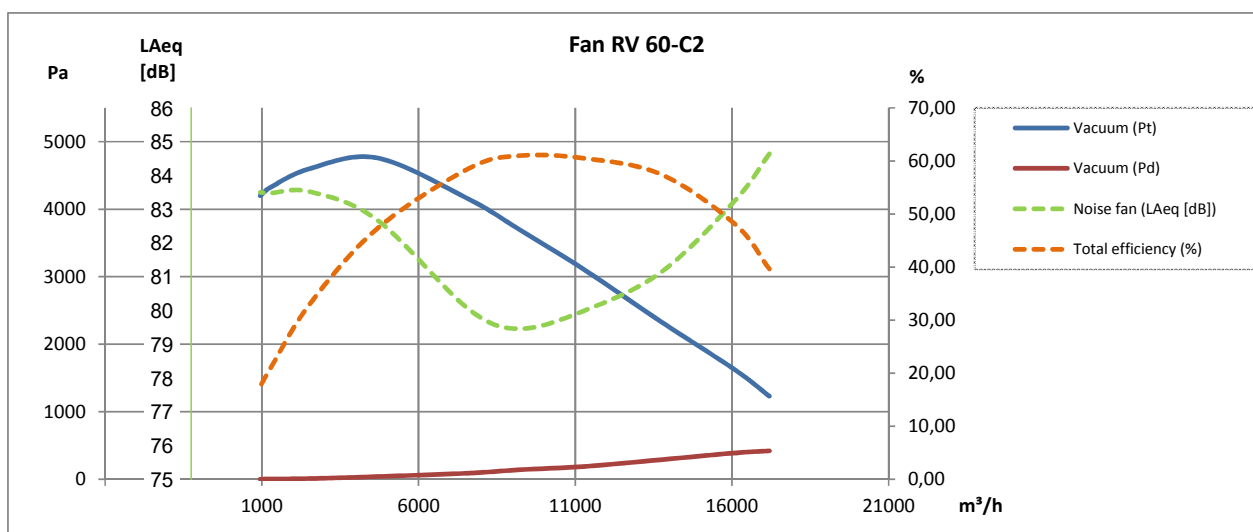

2-polet:

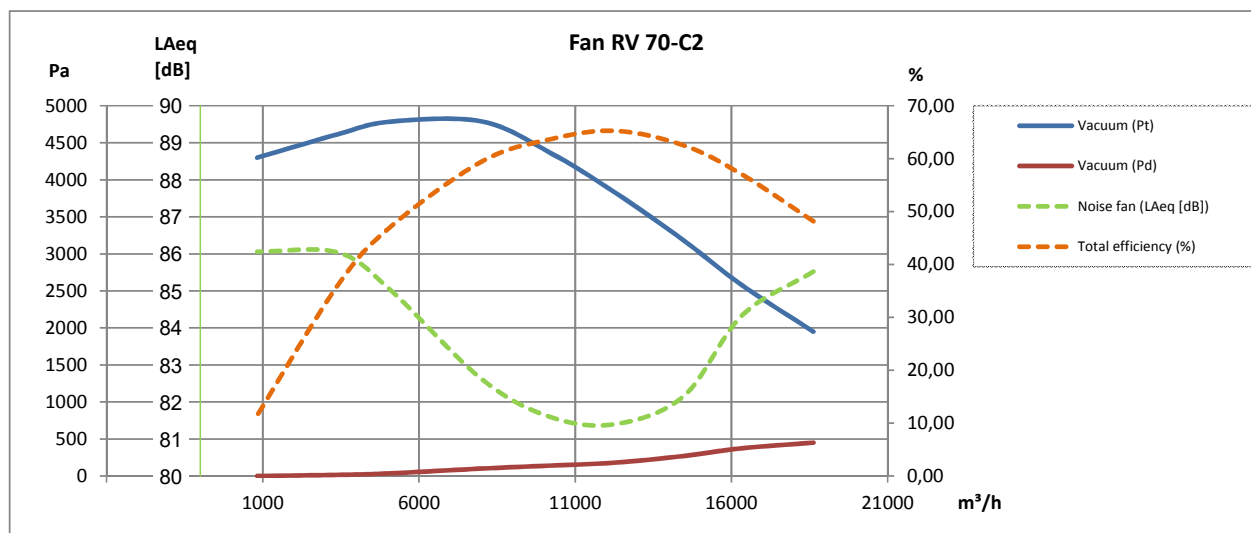

2-polet:

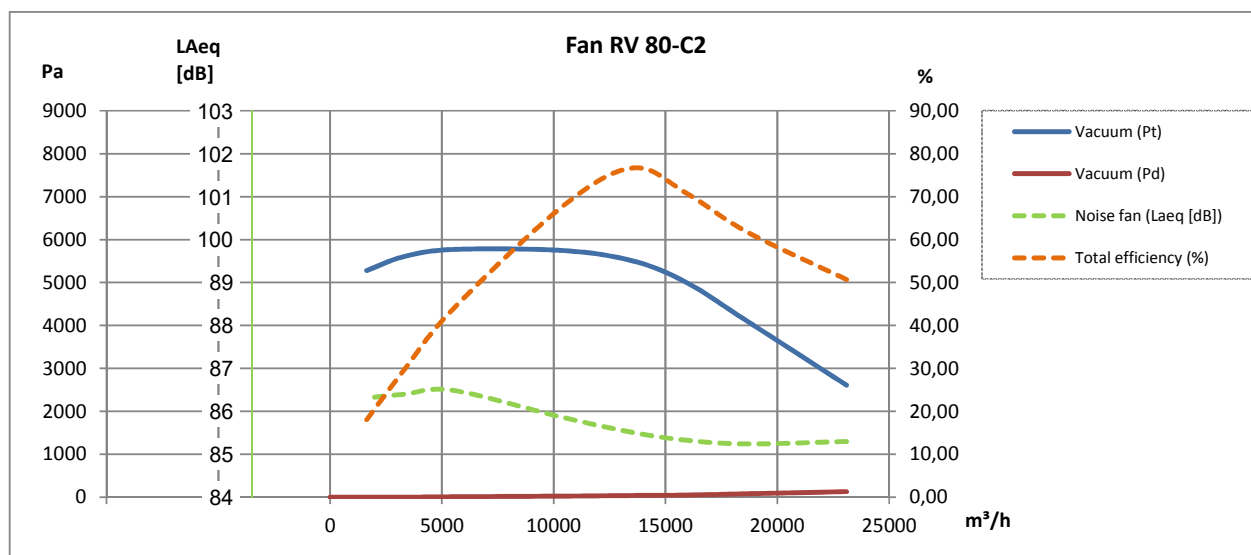

2-polet:

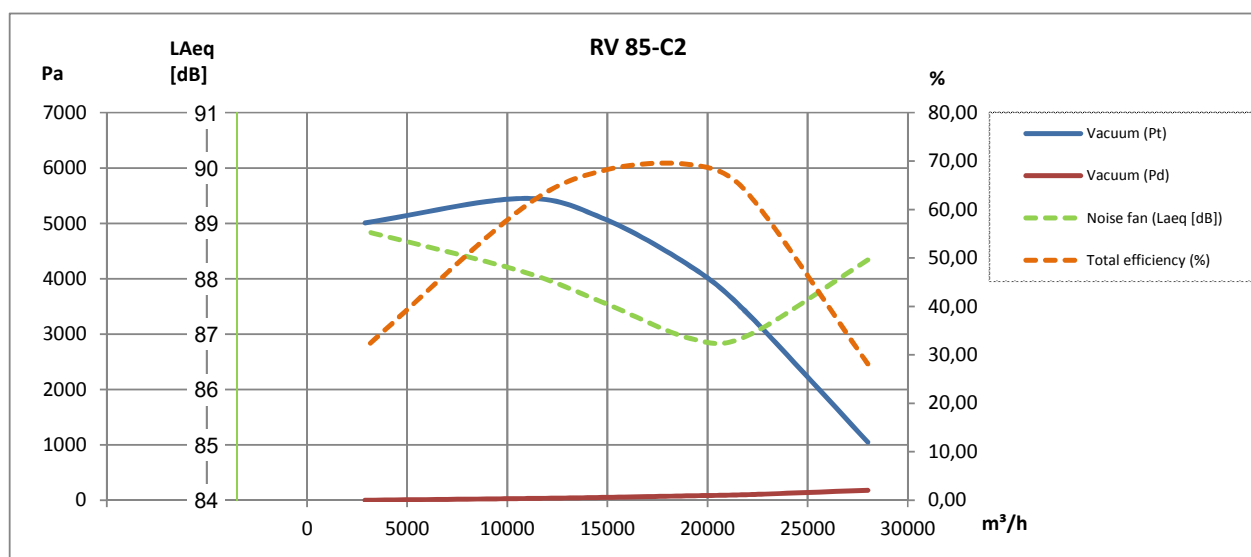

Rev. 05.23 Ret til ændringer forbeholdes

2-polet:

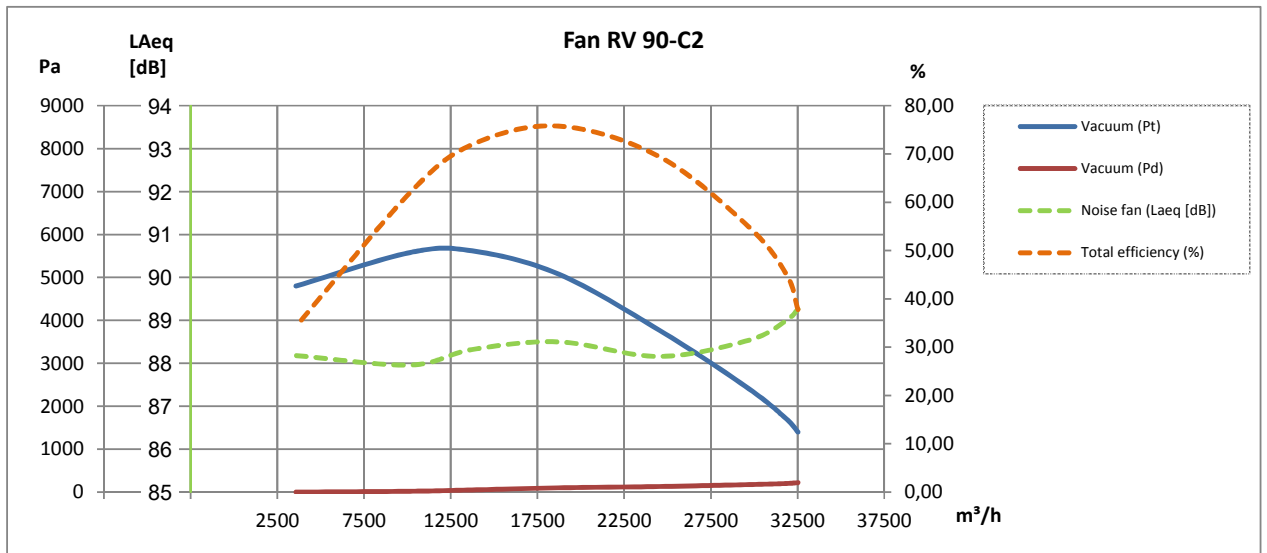

4-polet:

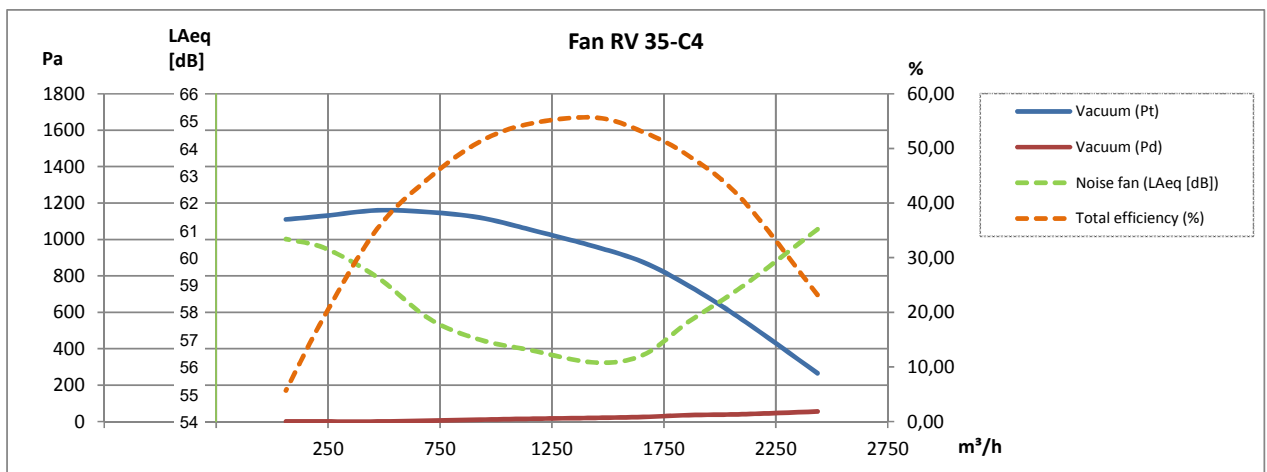

4-polet:

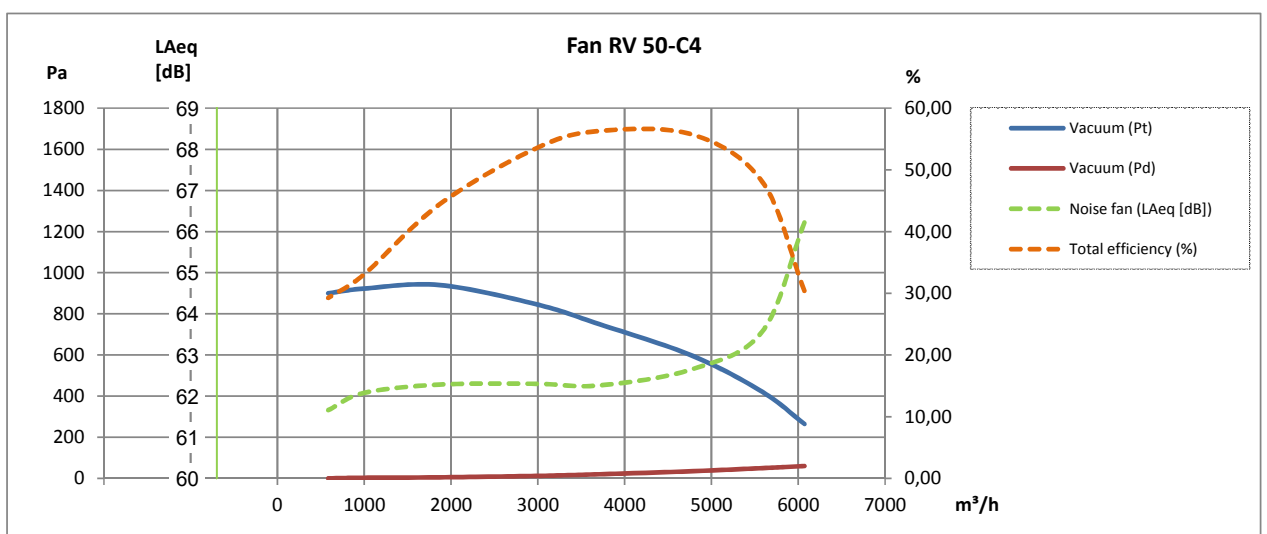

4-polet:

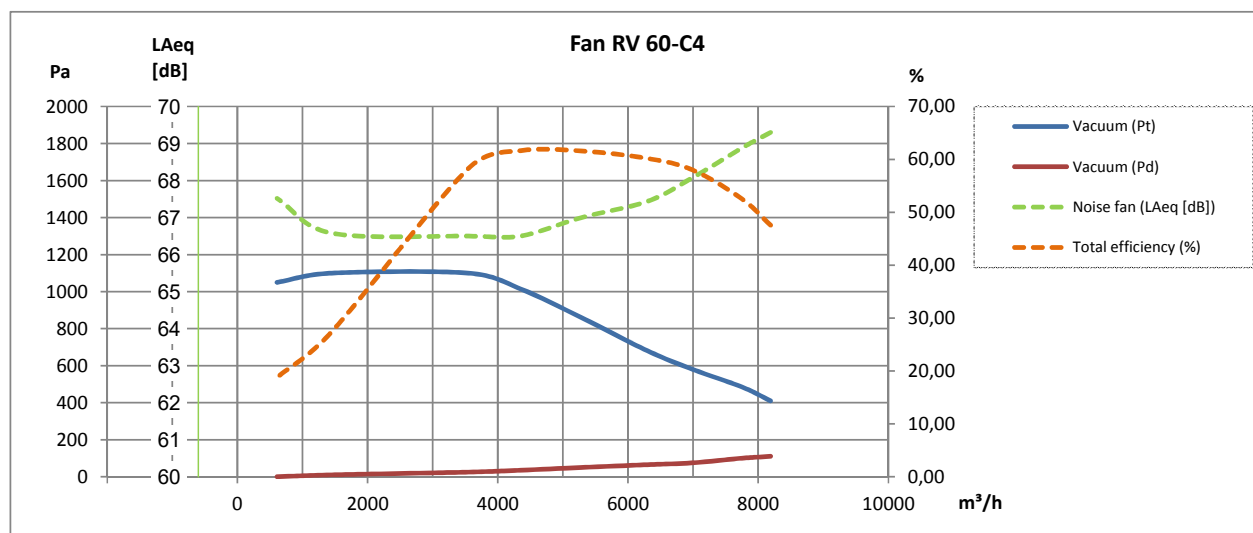

4-polet:

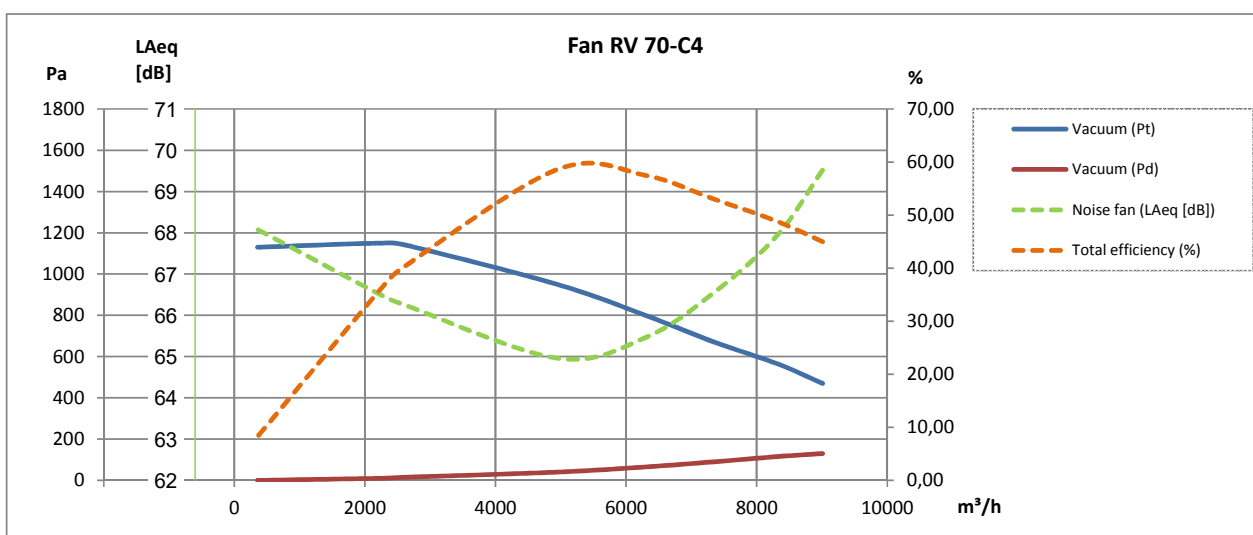

4-polet:

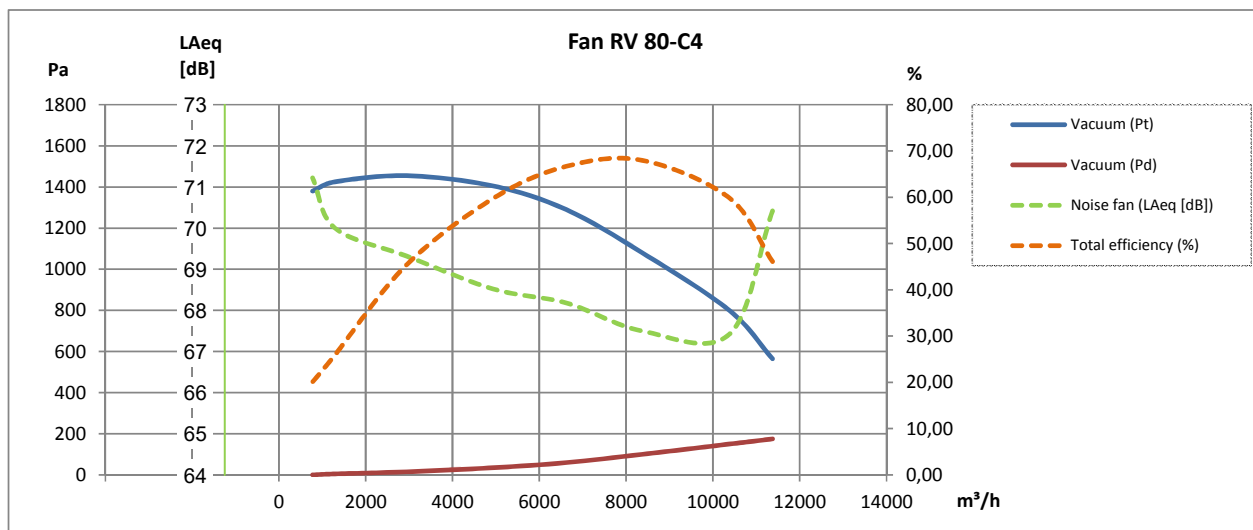

Rev. 05.23 Ret til ændringer forbeholdes

4-polet:

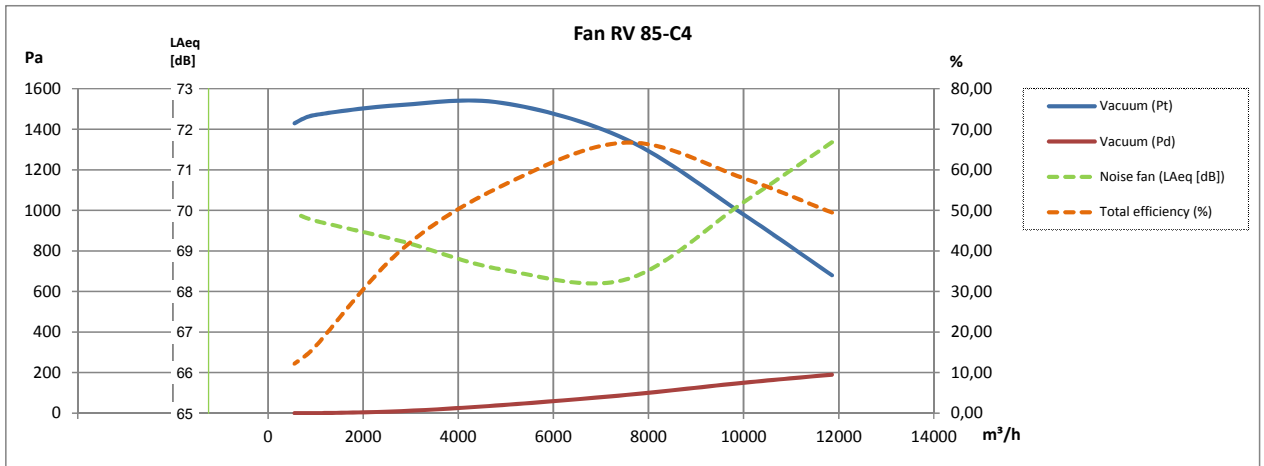

4-polet:

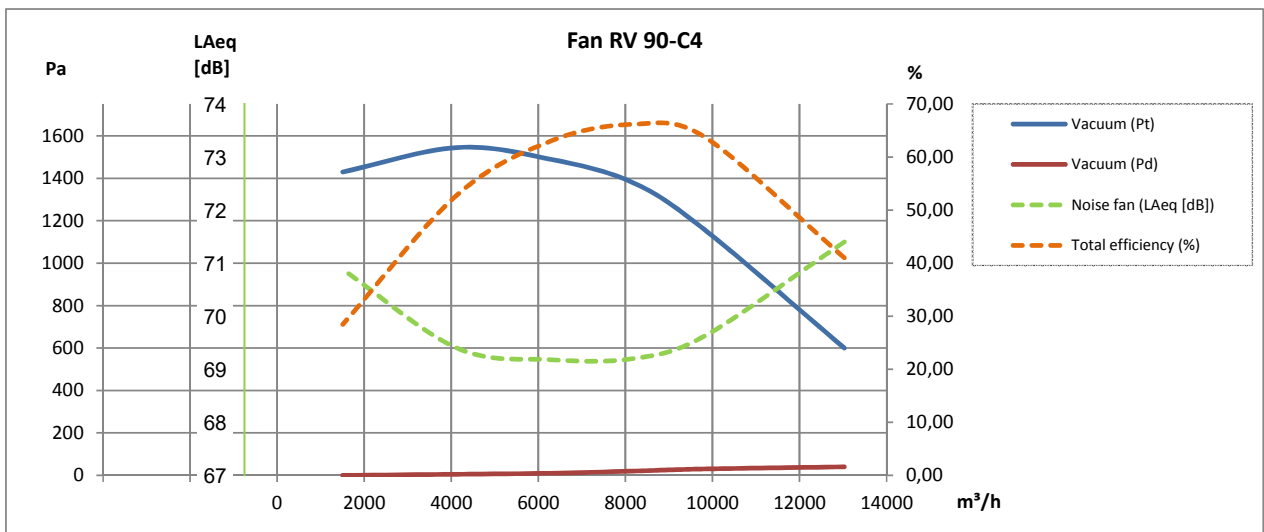

Beskrivelse	Varenr.
Tillæg for 60Hz drift (ekskl. evt. specialmotor)	09 185 010

Alle udgaver af ventilator type RV-C kan også leveres i en galvaniseret udgave med gnistsikring i kobber (Cu) på indløbsdysse!



Lyddæmpningskabinet type VB*:

Type (Position RD0)	Varenr.
RV 35/1	03 430 400
RV 35/2	03 430 700
RV 35/3	04 430 000
RV 45	03 436 400
RV 50	03 440 400
RV 60	03 445 400
RV 70	03 446 400
RV 80	03 447 000
RV 85	03 448 000
RV 90	03 449 000
Tillæg for lyddæmpningskabinet type VB med sideafkast, ventilatorposition RD90	03 551 000



* Kun for ren lufttransport



Desuden kan leveres:

- Trykvagt
- Montagebeslag
- Vibrationsdæmpere
- Sikkerhedsgitter
- FLEX fleksibel forbindelse
- Eksplosionsbeskyttet konstruktion til brug i ATEX zoner
- Motorstarter Y-D
- Frekvensomformer

Foto:
Danfoss Frekvensomformer type VLT

Ventilatorvinger:

Type	Nav [mm]	Ventilatortype**	[Hz]	Varenr.
RV 35/1	ø28	C2	50	03 400 705
RV 35/2	ø28	C2	50	03 401 705
RV 35/3	ø28	C2	50	03 400 205
RV 45	ø38	C2	50	03 406 405
RV 50	ø38	C2	50	03 410 405
RV 60	ø42	C2	50	03 415 005
RV 70	ø48	C2	50	03 417 305
RV 80	ø55	C2	50	03 418 00501
RV 85	ø55	C2	50	03 418 50501
RV 90	ø55	C2	50	03 419 00501
RV 35	ø19	C4	50	03 420 005
RV 50	ø24	C4	50	03 422 305
RV 60	ø28	C4-	50	03 423 005
RV 70	ø28	C4	50	03 425 305
RV 80	ø28	C4	50	03 426 00501
RV 85	ø38	C4	50	03 427 00501
RV 90	ø38	C4	50	03 428 00501
RV 35/1	ø28	C2	60	03 400 065
RV 35/2	ø28	C2	60	03 401 065
RV 35/3	ø28	C2	60	03 400 265
RV 45	ø38	C2	60	03 406 065
RV 50	ø38	C2	60	03 410 065
RV 60	ø42	C2	60	03 415 065
RV 70	ø48	C2	60	03 417 065
RV 80	ø55	C2	60	03 418 065
RV 85	ø55	C2	60	03 418 565
RV 90	ø55	C2	60	03 419 065
RV 35	ø19	C4	60	03 420 075
RV 50	ø24	C4	60	03 410 475
RV 60	ø28	C4	60	03 415 075
RV 70	ø28	C4	60	03 417 375
RV 80	ø28	C4	60	03 418 075
RV 85	ø38	C4	60	03 418 575
RV 90	ø38	C4	60	03 419 075

**Closed Transport (CT)

